

BUYLIGHTING



2014

Catalogue



Light, Years Ahead !!!!!™

CONTENTS

Pages 1-3: INDOOR CEILING AND WALL LIGHTS



Pages 4-5: INDOOR FLOOR AND FOOT LIGHTS



Pages 6-8: INDOOR SURFACE AND RECESSED SPOT LIGHTS



Pages 9: INDOOR SURFACE AND RECESSED DOWN LIGHTERS



Pages 10-12: INDOOR BENDABLE 240v TRACK SYSTEM



Pages 13-14: INDOOR BENDABLE 12v TRACK SYSTEM

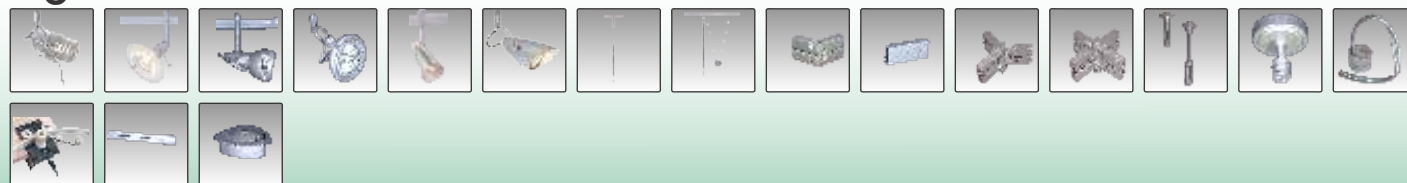

Pages 15-16: INDOOR OPEN CONDUCTOR WIRE LIGHT SYSTEM



Pages 17-19: INDOOR 2 & 3 WIRE TRACK SPOTS AND ACCESSORIES



Pages 20: INDOOR PENDANTS



Page 21- 25: OUTDOOR LIGHT FITTINGS



Pages 26-28: ELECTRICAL ACCESSORIES AND DIMMERS



All Electrical Installations by qualified electricians only
Instructions on website for download and/or included in packaging



JC522 "FUJI" LED ceiling/wall light

9W LED 650 lumen 3000K (Warm White)
240v dimmable driver
Lifetime: up to 30,000hrs
Colour: White
Class 1
220mm diameter
94mm height
QC21

COLOUR



13W LED 833 lumen 3000K (Warm White)

QC21
142mm height
330mm diameter
Class 1
Colour: White
Lifetime: up to 30,000hrs
240v dimmable driver

JC533 "FUJI" LED ceiling light



COLOUR



QC21
150mm diameter
Class 1
Colour: White
with frosted glass
Lifetime: up to 30,000hrs
240v non-dimmable driver
5W LED 270 lumen 3000K (Warm White)

JW505 "POM" LED wall light

JC522 "FUJI" LED ceiling/wall light

9W LED 650 lumen 3000K (Warm White)
240v dimmable driver
Lifetime: up to 30,000hrs
Colour: White
Class 1
220mm diameter
94mm height
QC21

COLOUR



JW200 "LOUVRE" LED wall light

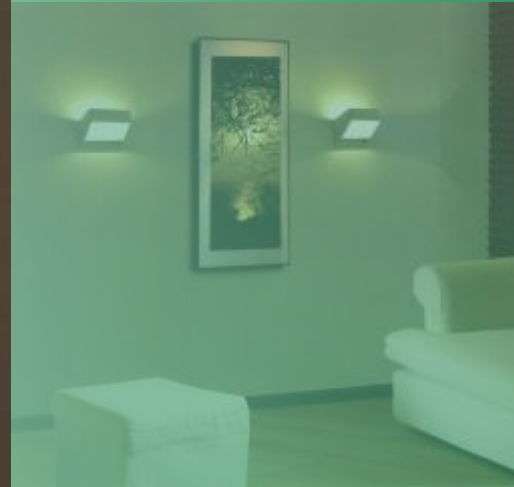

QC21
150mm wide
90mm deep
Class 1
Colour: White, Silver
Lifetime: up to 30,000hrs
240v non-dimmable driver
5W LED 310 lumen 3000K
COLOUR (Warm White)



JW22 - "BED-SIDE LIGHT"

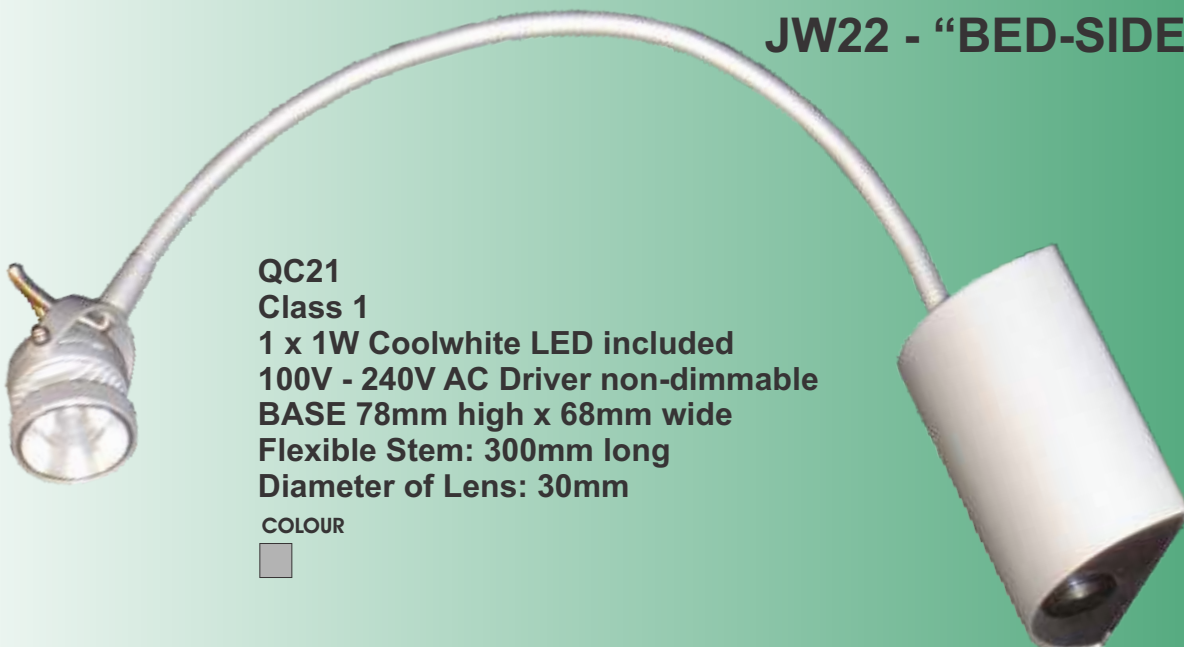

QC21
Class 1
1 x 1W Coolwhite LED included
100V - 240V AC Driver non-dimmable
BASE 78mm high x 68mm wide
Flexible Stem: 300mm long
Diameter of Lens: 30mm

COLOUR



With Switch

EC01 ROUND "Eyeled" LED floor light

0.3W LED
 12v Direct Current (DC)
 Driver supplied separately
 Lifetime: up to 100,000hrs
 316 stainless steel body
 Colour: WW, CW, Blue
 Class III
 45mm diameter, 40mm cut-out
 6.5mm fitting depth
 QC32
 IP67 (not suitable for outdoors)

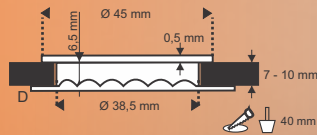

Floor EyeLED Accessories

ColorEye

EAPCS: Recessed Power feed for up to 22 fittings



EAPF10: 2-pin Power feed for up to 10 fittings



EACT: 'T' Splitter



EACX: 6m extension



EAPF40: Recessed Power feed for up to 40 fittings



EAES: End Stop



EACR: Carpet Ring

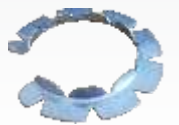

ES01 SQUARE "Eyeled" LED floor light

Indoor Eyeleds are available for use with:
 - Carpet
 - Tiles
 - Wood/Laminate/Parquet
 - Plaster



0.6W LED
 12v Direct Current (DC)
 Driver supplied separately
 Lifetime: up to 100,000hrs
 316 stainless steel body
 Colour: WW, CW, Blue
 Class III
 45mm square, 40mm square cut-out
 6.5mm fitting depth
 QC32

IP67 (not suitable for outdoors)

EM01 ROUND "ColorEye" LED floor light

0.42W LED
 12v Direct Current (DC)
 Special Driver supplied separately
 Lifetime: up to 50,000hrs
 316 stainless steel body
 Colour changing
 Class III
 45mm diameter, 40mm cut-out
 6.5mm fitting depth
 QC32
 IP67 (not suitable for outdoors)



The colour changing Eyeled continuously changes across the full spectrum of colours from blue through to red and white.

A quick on/off at the switch allows one to select the Eyeled colour at that moment. Switching the COLOREYE off for more than 6 seconds resets the string.

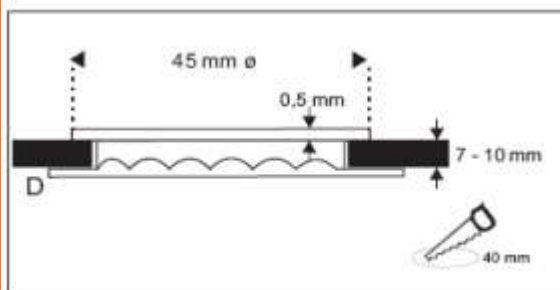
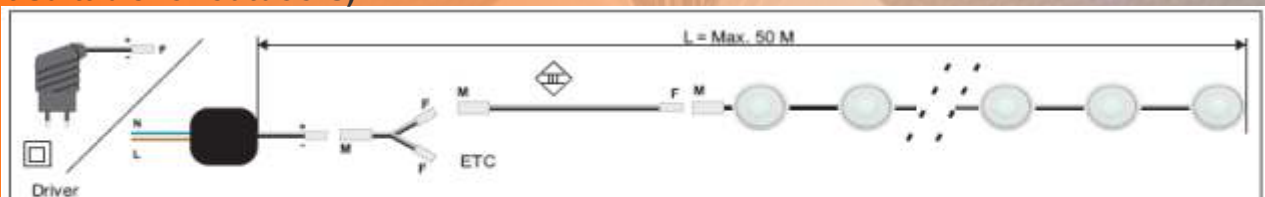

* Suitable for carpet 7 - 10 mm.

* Underfloor 7 mm recommended to enable a norm conform installation procedure.



EP01hW180 "PowerEYE 180" LED

1.5W LED 17 lumen 5500K
12v Direct Current (DC)
Lifetime: up to 50,000hrs
316 Stainless Steel Casing
Class III
45mm diameter 40mm cutout
6.5mm height
QC33
IP67
Not for outdoor use or floor use

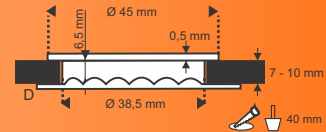

PowerEye

EAPF40: Recessed
Power feed for
up to 8 fittings



EAPF10: 2-pin
Power feed for
up to 3 fittings



T connector and extension cable available



IP67
Not for outdoor use or floor use
QC33
6.5mm height
45mm diameter 40mm cutout
Class III
316 Stainless Steel Casing
Lifetime: up to 50,000hrs
12v Direct Current (DC)
1.5W LED 23 lumen 5500K

EP01hW360 "PowerEYE 360" LED

MORE DETAILS AT WWW.EYELEDS.COM

L100

Mini Square Recessed Wall & Ceiling LED

Colour: SILVER, Frosted Lens (White Light)
Voltage: 12V 50Hz: Suitable for use with any
Standard Wire-Wound 12V Transformer.
Wattage: 0,3W
Illuminance: 54 lux at 0,5m
For Indoor Use Only
Lamp Life: 100,000 hours
Size: 40mm(W) x 40mm(H) x 50mm(D)
Cut-out: 35mm
Class III QC31

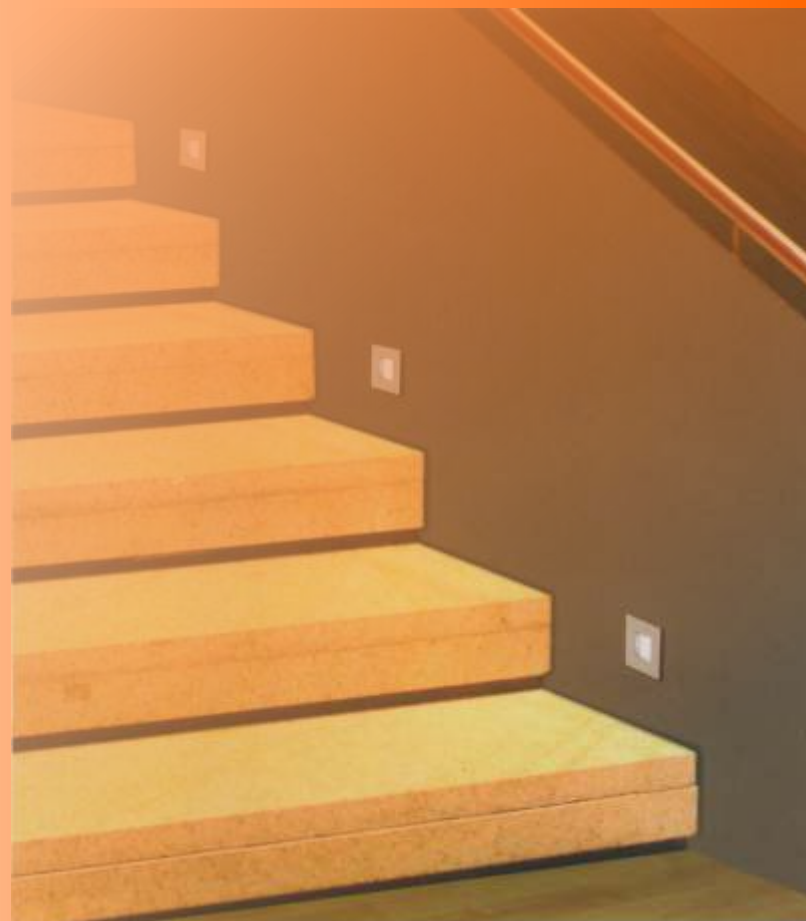
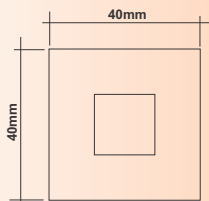

ST2 - 2 Spot/Pendant
ST3 - 3 Spot/Pendant

“RECTANGULAR”

Base incl Electronic Transformer
360mm x 90mm x 45mm

Base Colours: White, Black, Silver, Chrome

Fitting Colour: See pages 17 to 20

Class I QC21



COLOUR



SR2 - 2 Spot/Pendant
SR3 - 3 Spot/Pendant

“ROUND”

Base incl Electronic Transformer
210mm x 70mm

Base Colour: White, Silver, Chrome

Fitting Colour: See pages 17 to 20

Class I QC21

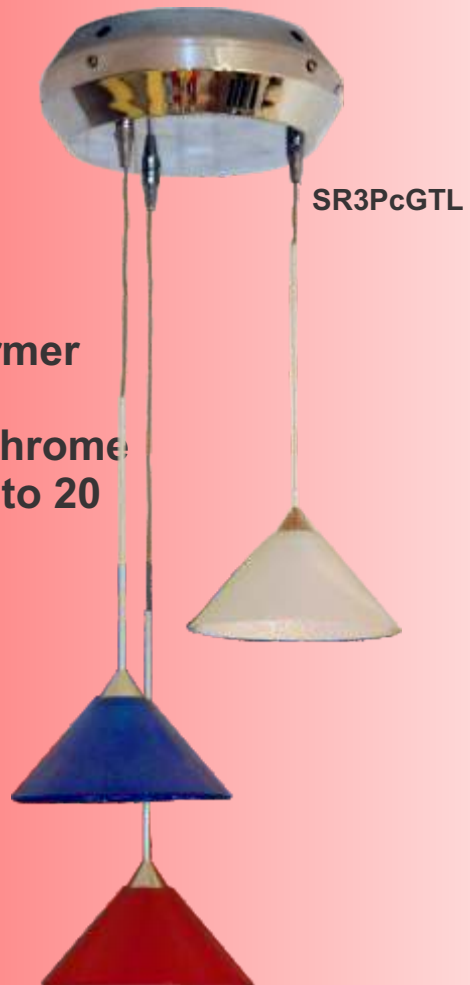

COLOUR



ST and SR bases can be supplied with 240v spot heads

ALSO AVAILABLE USING THE FOLLOWING SPOT HEADS OR PENDANTS ON PAGES 17 to 20





S028bS3

SS3

“MOUSE”

Surface mount base
includes 50W Electronic Transformer
L X W x H 100mm x 60mm x 30mm
Base Colour: White, Black, Silver
Fitting Colour: See pages 17 to 20
CLASS II QC21

COLOUR



S229wS8

SS8

“ROUND”

Surface mount base
includes 50W Electronic Transformer
100mm diameter x 35mm high
Base Colour: White, Black, Silver, Chrome
Fitting Colour: See pages 17 to 20
CLASS I QC21

COLOUR

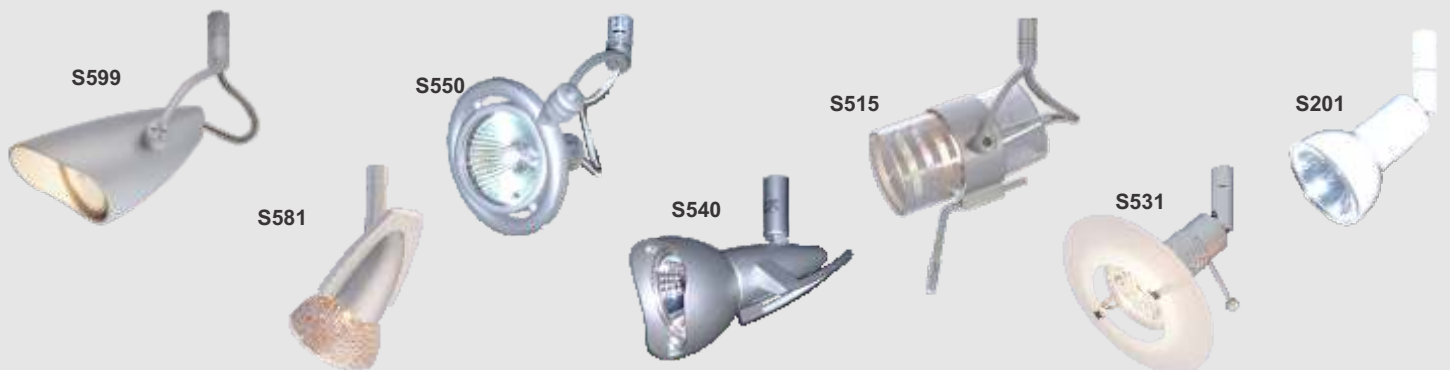



S201sS7

SS7

“LARGE ROUND” Base

Remote Transformer not included

100mm diameter x 20mm high

Base Colour: White, Black, Silver, Chrome

Fitting Colour: See pages 17 to 20

Class I or Class III QC: 21

COLOUR

SS5

“RECESSED” Base

Remote Transformer not included

80mm diameter

Base Colour: White, Black, Silver, Chrome

Fitting Colour: See pages 17 to 20

Class I or Class III QC:21

COLOUR



S581sS5



S540sS4

SS4

“FLUSH” Base

Remote Transformer not included

38mm diameter

Base Colour: White, Black, Silver, Chrome

Fitting Colour: See pages 17 to 20

Class III QC:21

COLOUR

ALSO AVAILABLE USING THE FOLLOWING SPOT HEADS OR PENDANTS ON PAGES 17 to 20



EP01hW360 "PowerEYE 360" LED

EAPF40: Recessed Power feed for up to 8 fittings

EAPF10: 2-pin Power feed for up to 3 fittings



T connector, extension cable

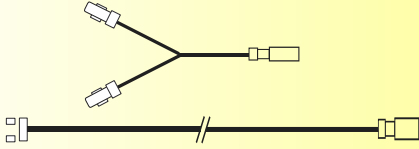

IP67 (Not for outdoor use)
 QC33
 6.5mm height
 45mm diameter 40mm cutout
 Class III
 316 Stainless Steel Casing
 Lifetime: up to 50,000hrs
 12v Direct Current (DC)
 1.5W LED 23 lumen 5500K

MORE DETAILS AT WWW.EYELEDS.COM

JB29

"COVERED TILT"
 Machined Aluminium
 with Cover Glass
 30degree Tilt
 75mm cut-out
 Class III QC22

50W
 MR16

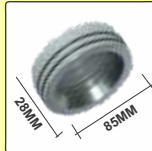

IP65 TILT Downlighter suitable for use in bathrooms, kitchens and covered patio areas

JC55 (SILVER / WHITE)
 'PUK' Ceiling fitting supplied
 with 7W GX53 CFL Lamp
 Coolwhite
 and
 Warmwhite
 Class II QC21



85mm diameter x 25mm high

JC24
 "ROUND TILT"
 Die Cast
 30 degree Tilt
 75mm cut-out
 Class III QC21

50W
 MR16

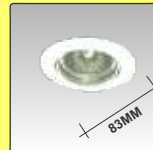

JC15
 "SQUARE TILT"
 Die-Cast
 30degree Tilt
 75mm cut-out
 Class III QC21

50W
 MR16

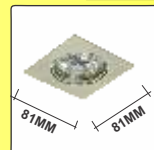

**K543
"NEPRO T5"
Fluorescent**

COLOUR

Class: I
QC: 32
Lamp: 2 x 24w T5
Max 50w

T5 Fluorescent Downlighter
Can also be surface mounted



**K501
"SATELIT" Spot**

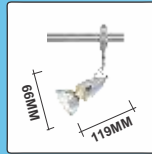

Class: I
QC: 32
Lamp: GZ10
Max 50w

COLOUR

**K502
"NEON" Spot**

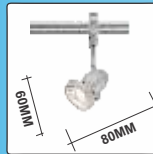

Class: I
QC: 32
Lamp: GZ10
Max 50w

COLOUR

**K515a
"LIMA" Spot**



Class: I
QC: 32
Lamp: GZ10
Max 50w

COLOUR

**K529
"KANO" Spot**

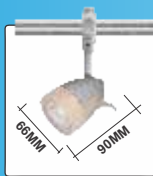

Class: I
QC: 32
Lamp: GZ10
Max 50w

COLOUR

**K599a
"ARGON" Spot**

Class: I
QC: 32
Lamp: GZ10
Max 50w
For use with 'Alu' lamps only

COLOUR

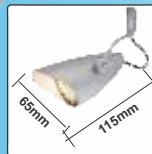

**K598
"NEAT" Spot**



Class: I
QC: 32
Lamp: GZ10
Max 50w

COLOUR

**K550a
"LIKA" Spot**



Class: I
QC: 32
Lamp: GZ10
Max 50w

COLOUR

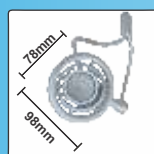

**K515b
"LIMA" Spot**



Class: I
QC: 32
Lamp: MR16
Max 50w

COLOUR
[Grey swatch]



**K581MHR
"ROCKET" Spot**



Class: I
QC: 32
Lamp: MR16
Max 50w

COLOUR
[Grey swatch]
SHADE
[Grey swatch]

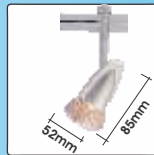

**K540MST
"STAR" Spot**



Class: I
QC: 32
Lamp: MR16
Max 50w

COLOUR
[Grey swatch]
SHADE
[White, Grey, Blue swatches]

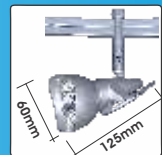

**K531GSY
"SYROS" Spot**

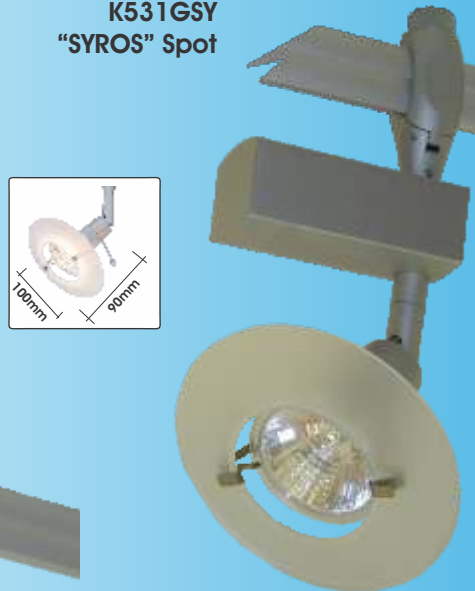

Class: I
QC: 32
Lamp: MR16
Max 50w

COLOUR
[Grey swatch]
SHADE
[White swatch]

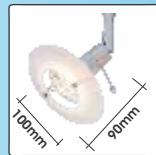

**K550b
"LIKA" Spot**



Class: I
QC: 32
Lamp: MR16
Max 50w

COLOUR
[Grey swatch]



**K599b
"ARGON" Spot**

Class: I
QC: 32
Lamp: MR16
Max 50w

COLOUR
[Grey swatch]

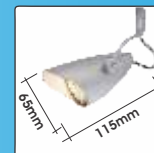

for use with 'Alu' lamps only



K503 "NEPRO"
200mm wide
300W Max R7s



KPW525 "BARRO"
70mmdiameter
x 135mm high
50W Max

Ceiling Connectors
KC5 - 2.5m Cable Support
KC4 - Telescopic 140-240mm
KC1 - 100mm
KC0 - 50mm

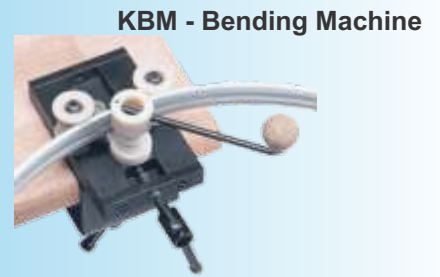

KBM - Bending Machine

KCW - Wall Bracket
Telescopic 135-218mm

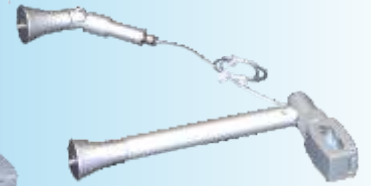

KCF - Flexible Joiner
(Conductive)

KCS - Straight Joiner
(Conductive)

KCN - Straight Joiner
(Non-Conductive (Insulated))



125mm diameter
x 230mm high

60W Max
G9

KPC - Power Connector
100mm



KCT - "T" Joiner

KPF - Power Feed



500mm flexible connector

Flexible Track
KTR1 - 1m Track Straight
KTR2 - 2m Track Straight



Suitable for use with KC1
ceiling connector

Track can be shaped on site using a track bending machine (KBM) or supplied to customer specifications

MAXIMUM 2400WATTS (10AMPS) PER CIRCUIT



KEC - End Caps

F599s
"ARGON" Spot

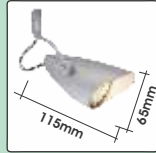

USE WITH ALU LAMP

Class: III
QC: 22
Lamp: 50W MR16

COLOUR
■



F515s
"LIMA" Spot



Class: III
QC: 22
Lamp: 50W MR16

COLOUR
■

F540sGSTf
"STAR" Spot
with Glass Shade

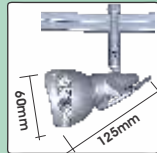

F550s
"LIKA" Spot



Class: III
QC: 22
Lamp: 50W MR16

COLOUR
■

F540sGSTu **F540sMSTs**

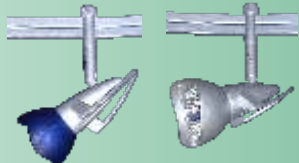

Class: III
QC: 22
Lamp: 50W MR16

COLOUR
■

USE ALU LAMP WITH METAL SHADE

F581sMHRs
"ROCKET" Spot with Mesh Shade



Class: III
QC: 22
Lamp: 50W MR16

COLOUR
■



F581s
"ROCKET" Spot without Shade

F531sGSTf
"SYROS" Spot with Glass Shade

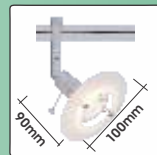

Class: III
QC: 22
Lamp: 50W MR16

COLOUR
■



F531s
"SYROS" Spot no shade



FC0
Ceiling
Connector
Short



FC1
Ceiling
Connector
10cm



FCA - Angle Joiner
2-way flexible connector



FCN - Straight Joiner
(Non Conductive - Insulated)
FCS - Straight Joiner
(Conductive)



FC5
Ceiling
Connector
Cable. 2.5m

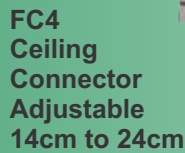

FC4
Ceiling
Connector
Adjustable
14cm to 24cm



F329 2M Pendant Dropper

F328 2M "YO-YO" Pendant Dropper



FCX - "X" Joiner
4-way flexible connector



FCT - "T" Joiner
3-way flexible connector



FPC - Power Connector
Suitable for use with FC1
Ceiling Connector

FPF - Power Feed
(Transformer to Track)

FTM - Manta Transformer
210VA
300VA



Includes FPF
Power Feed



300mm Flexible Tail

FBM - Bending Machine

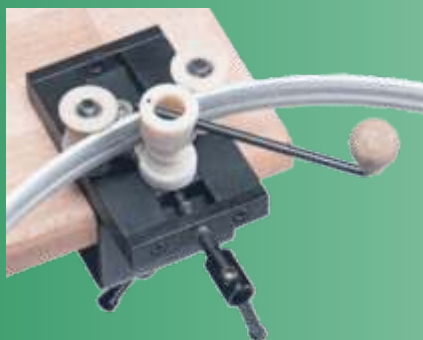

Flexible Track
FTR1 - 1m Track Straight
FTR2 - 2m Track Straight



Track can be shaped on site using a track bending machine (FBM) or supplied to customer specifications

WL001
"HORIZONTAL"
Spot

Chrome & Silver

50W
MR16

Cable Spacing
150mm
Length 200mm



WL001A
"HORIZONTAL"
Spot

Chrome & Silver

50W
MR16

Cable Spacing
150mm
Length 200mm



WL588
"VERTICAL"
Spot

Chrome & Silver

50W
MR16

Cable Spacing
>115mm
Short 150mm
Medium 255mm
Long 500mm



C225
"CUBE"
Spot

Chrome & Glass

50W
BIPIN

Cable Spacing
115mm
Length 115mm

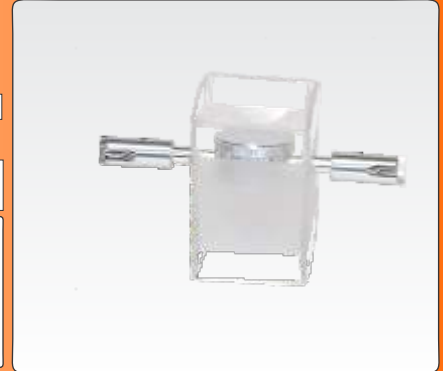

WL052
"QR111"
Spot

Chrome & Black

50W
QR111

Cable Spacing
115mm



WL008
"CIRCULAR"
Spot

Chrome & Silver

50W
MR16

Cable Spacing
150mm



C099
"COMET"
Spot

Chrome & Silver

35W
MR16

Cable Spacing
115mm
Diameter
60mm



Suitable for 20W or 35W Dichroic Only

WL909
"TUBE"
Spot

Chrome

1W
LED



SHADE OPTION

MHR - Fine Mesh Basket

Silver

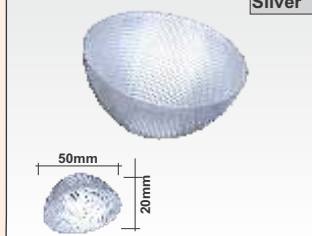

Photometrics for Osram 46870SP 50W dichroic lamp

H(M)	∅	10°	E(lux)
0.3	12		97800
0.5	20		41800
1.0	40		11000
2.0	80		2800

Photometrics for Osram 46870WFL 50W dichroic lamp

H(M)	∅	38°	E(lux)
0.3	29		17400
0.5	48		7440
1.0	97		2000
2.0	194		490

SEE OTHER PENDANT OPTIONS ON PAGE 20

C072
"PT"
Pendant
Colours
Fitting / Shade
 Chrome | Various
 Blue

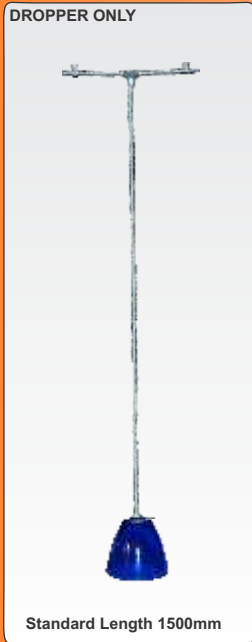

Standard Pendant Dropper Supplied as Pictured
 Shades Supplied Separately
 Cable Spacing 150mm

GMC - MERCURE



MTC - ALU CONE



G30 - PIXIE



GOR - ORION



GTL - MARTINI

ACCESSORIES FOR COMET WIRE SYSTEM

WP4 - Transformer
 200VA
 300VA

Chrome
 White
 Silver



C4 - Transformer
 210VA Econo
 130mm dia x 75mm high

Silver



WP01060 - Mounting Kit
 Wall & Ceiling
 Short - 60mm Stand-Off
 (Four Pieces)



WP02 - Mounting Kit
 Wall (Four Pieces)

Normal - 4 x Turnbuckle Set

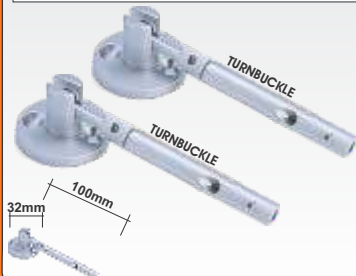

WP01100 - Mounting Kit
 Wall & Ceiling

Long - 100mm Stand-Off
 (Four Pieces)



WP07N - Cable Joiner
 (Two Pieces)

N - Non Conductive



Used to Separate Transformers where more than 300VA is required on a single system

WP3B - Ceiling Supports
 (Two Pieces)

Standard - 60mm Stand-Off
 Standard - 100mm Stand-Off
 Standard - 200mm Stand-Off



WP54P - Carrier Cable

4P - 4mm² PVC insulation



WP09 - 90° cable crossover kit
 Conductive
 (Two Pieces)



SEE ACCESSORIES ON PAGE 19

R028sT2 / T23
"ROUND" Spot
 58mm x 70mm



Class: I
 2-wire QC11
 3-wire QC21
 Lamp: MR16
COLOUR

R018sT2 / T23
"SQUARE" Spot
 58mm x 70mm



Class: I
 2-wire QC11
 3-wire QC21
 Lamp: MR16
COLOUR



R599sT2 / T23
"ARGON" Spot
 60mm x 115mm



Class: I
 2-wire QC11
 3-wire QC21
 Lamp: MR16
COLOUR

R515sT2 / T23
"LIMA" Spot
 60mm x 105mm



Class: I
 2-wire QC11
 3-wire QC21
 Lamp: MR16
COLOUR

R540sGSTfT2 / T23
"STAR" Spot
 60mm x 125mm



R540 also available with blue glass or metal shade

Class: I
 2-wire QC11
 3-wire QC21
 Lamp: MR16
COLOUR

R581sMHRT2 / T23
"ROCKET" Spot
 52mm x 85mm



Class: I
 2-wire QC11
 3-wire QC21
 Lamp: MR16
COLOUR

R581sT2/T23



R531sGSYfT2 / T23
"SYROS" Spot
 100mm x 90mm



Class: II
 IP: 20
 QC: 22
 Lamp: MR16
COLOUR

R531sT2/T23



R550sT2 / T23
"LIKA" Spot
 80mm diameter



Class: I
 2-wire QC11
 3-wire QC21
 Lamp: MR16
COLOUR

R229sT2 / T23
"CONICAL" Spot
 55mm x 100mm



Class: I
 2-wire QC11
 3-wire QC21
 Lamp: MR16
COLOUR

R230wT2 / T23
"BASIC" Spot
 20mm x 23mm



Class: I
 2-wire QC11
 3-wire QC21
 Lamp: MR16
COLOUR

R201wT2 / T23
"DOME" Spot
 52mm x 65mm



Class: I
 2-wire QC11
 3-wire QC21
 Lamp: MR16
COLOUR

R226bT2 / T23
"WING" Spot
 58mm x 100mm



Class: I
 2-wire QC11
 3-wire QC21
 Lamp: MR16
COLOUR

R600TA / TA3
"LED TRACK" Spot
50mm x 130mm



Class: I
2-wire QC11
3-wire QC21
Lamp: 10w LED built in

COLOUR
[Grey swatch]

R030sTA / TA3
"BARREL" Spot
58mm x 78mm



Class: I
2-wire QC11
3-wire QC21
Lamp: GU10

COLOUR
[Black, White, Grey swatches]

R235sTA / TA3
"BASIC GU10" Spot
45mm x 53mm



Class: I
2-wire QC11
3-wire QC21
Lamp: GU10

COLOUR
[Black, White, Grey swatches]

R550sTA / TA3
"LIKA" Spot



Class: I
2-wire QC11
3-wire QC21
Lamp: GU10

COLOUR
[Grey swatch]

R503TA / TA3
"NEPRO" Spot
300W Rx7s



Class: I
2-wire QC11
3-wire QC21
Lamp: Rx7s

COLOUR
[Grey swatch]

R599TA / TA3
"ARGON" Spot



Class: I
2-wire QC11
3-wire QC21
Lamp: GU10

COLOUR
[Grey swatch]

R515TA / TA3
"LIMA" Spot



Class: I
2-wire QC11
3-wire QC21
Lamp: GU10

COLOUR
[Grey swatch]

R028TA / TA3
"ROUND" Spot



Class: I
2-wire QC11
3-wire QC21
Lamp: GU10

COLOUR
[Black, White, Grey swatches]

R018TA / TA3
"SQUARE" Spot



Class: I
2-wire QC11
3-wire QC21
Lamp: GU10

COLOUR
[Black, White, Grey swatches]

3 WIRE TRACK ACCESSORIES

RCS3 - Track Straight Connector

COLOUR



RCL3 - Track "L" Connector

COLOUR



RCT3 - Track "T" Connector

COLOUR



RTR - Track (3 Wire)

Available in 1m, 1.5m and 2m
MAXIMUM 16A on one track system

COLOUR



RTA3 - Track Adaptor w/o Transformer

COLOUR



RT23 - Track Adaptor

115L x 35W x 25H

COMES WITH 50VA ELECTRONIC TRANSFORMERS

COLOUR

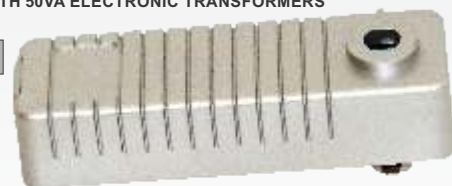

Note that losses across the connectors will reduce the carrying capacity of the track.

2 WIRE TRACK ACCESSORIES

RPF - Floating Canopy Power Feed for Track

COLOUR



RCT - Track "T" Connector

COLOUR



RCX - Track "X" Connector

COLOUR



RCF - Track Flexible Bend

COLOUR



(Silver and Black with a white insert)



RCS - Track Straight Connector

COLOUR

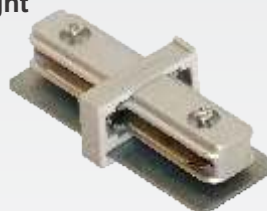

RCL - Track "L" Connector

COLOUR



RTA - Track Adaptor w/o Transformer

COLOUR



RT2 - Track Adaptor

90L x 35W x 25H

COMES WITH 50VA ELECTRONIC TRANSFORMERS

COLOUR

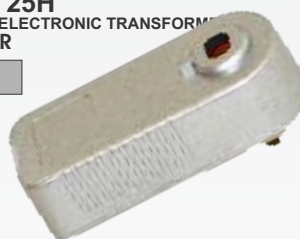

RT3 - Track Adaptor

120L x 35W x 25H

COMES WITH 50VA ELECTRONIC TRANSFORMERS

COLOUR



Note that losses across the connectors will reduce the carrying capacity of the track.

12V SHADES CAN BE ROD OR CABLE SUSPENDED

Line Voltage Pendants (240V)

Available as shown

Can be adapted for:

1. 240V Flexible track
2. Square Track
3. Surface Mount

KPW525 - BARRO



Size 125mm diameter x 230mm high
60W Max G9 Lamp

KPW650 - BIBA



Size 70mm diameter x 135mm high
50W Max GU10 Lamp (Par16)

12V 50W MR16 or Bi-Pin Pendants

Can be adapted for:

1. 12V Flexible track
2. 240V Flexible track
3. Comet Wire System
4. Square Track
5. Surface Mount



G30 - PIXIE

Size 95mm diameter x 160mm high

12V 50W MR16 or Bi-Pin Pendants

Can be adapted for:

1. 12V Flexible track
2. 240V Flexible track
3. Comet Wire System
4. Square Track
5. Surface Mount

Size 90mm diameter x 80mm high



GMC - MERCURE

12V 50W MR16 or Bi-Pin Pendants

Can be adapted for:

1. 12V Flexible track
2. 240V Flexible track
3. Comet Wire System
4. Square Track
5. Surface Mount



Size 140mm diameter x 65mm high

GTL - MARTINI

12V 50W MR16 or Bi-Pin Pendants

Can be adapted for:

1. 12V Flexible track
2. 240V Flexible track
3. Comet Wire System
4. Square Track
5. Surface Mount



Size 105mm diameter x 135mm high
MTC - ALU CONE

12V 50W MR16 or Bi-Pin Pendants

Can be adapted for:

1. 12V Flexible track
2. 240V Flexible track
3. Comet Wire System
4. Square Track
5. Surface Mount



Size 128mm diameter x 105mm high

"Triplex" Glass
GOR - ORION

PLEASE SPECIFY IF BI-PIN LAMP IS TO BE USED SO THAT THE CORRECT DROPPER CAN BE SUPPLIED

JF536 Flood



The JF536cw is a Black UV Powder Coated cast aluminium outdoor 30 watt LED flood light. Ideal for replacing conventional metal halide or halogen fittings. It is a Surface Mount fitting

The fitting is complete with a 30W LED driver. The reflector is an aluminium clear vacuum reflector and the diffuser is made of 4mm glass.

Class I IP65 QC32

COLOUR

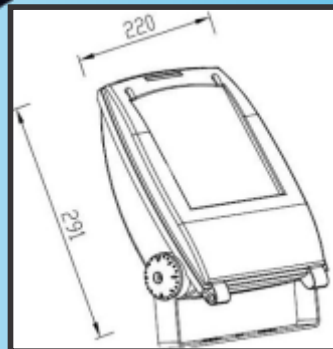
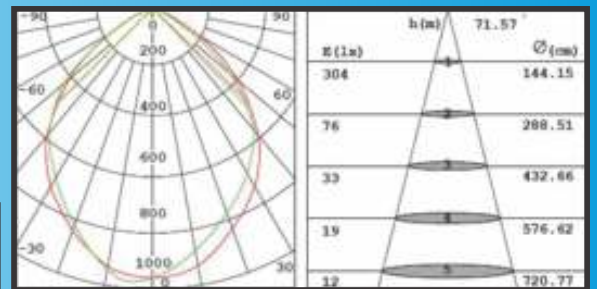

JGS851 Spike Light

The spike light is a 240v AC (Class I) fitting with a built in 350ma power supply driving 6 x 1W LED's with a 60deg lens. The casing is made from an aluminium alloy with a Silver Grey powder coated finish.

The fitting has an adjustable head and is supplied with a 30cm flexible cable and aluminium alloy spike

Class I IP65 QC32

COLOUR

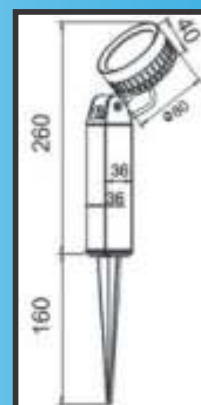
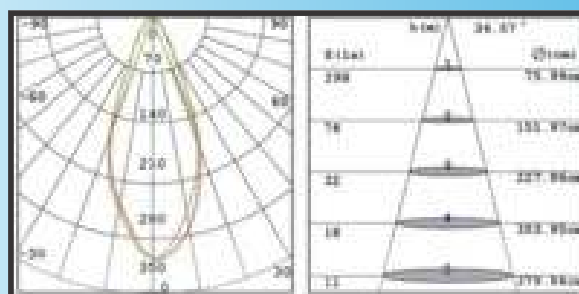



Eyeleds® Outdoor Basic, low profile LED light fixtures, install flush into most exterior surfaces. The fitting recesses into a 40mm diameter hole, drilled through the surface of the material. The fixtures are made of top quality materials and components that are resistant to corrosion and UV-radiation. The solid construction is engineered to withstand heavy use: walking or even driving over the lights is not a problem.

FEATURES & BENEFITS

- Easy to install LED luminaire, designed for exterior surfaces
- Fixture recesses 27mm into a 40mm diameter hole
- IP67 junction box included with each LED unit
- Powered by a 12V DC, short circuit protected LED driver
- Sustainable SMD-LED that consumes only 0.3W of energy
- Cool to the touch; fixtures will not get hotter than 34°C
- UV-resistant lens and marine grade stainless steel (316)
- "Walk/drive-over" construction, for loads up to 2850N/285kg
- Tested for conditions, ranging from -35°C to +65°C

EEX01 ROUND Outdoor "EYEled" LED ground light

Outdoor EYEled Accessories

EAXECO10
10m extension
cables



EAPECO: IP67
Power feed for
up to 40 fittings



EACB: Installation
Box



**0.3W LED
12v Direct Current (DC)
Driver supplied separately
Lifetime: up to 100,000hrs
316 stainless steel body
Class III
45mm diameter, 40mm cut-out
50mm mounting depth
QC33**

**IP67 (Suitable for outdoor use in coastal areas)
Colour: WW (2700K), CW (5500K), Blue**



Supplied individually as shown

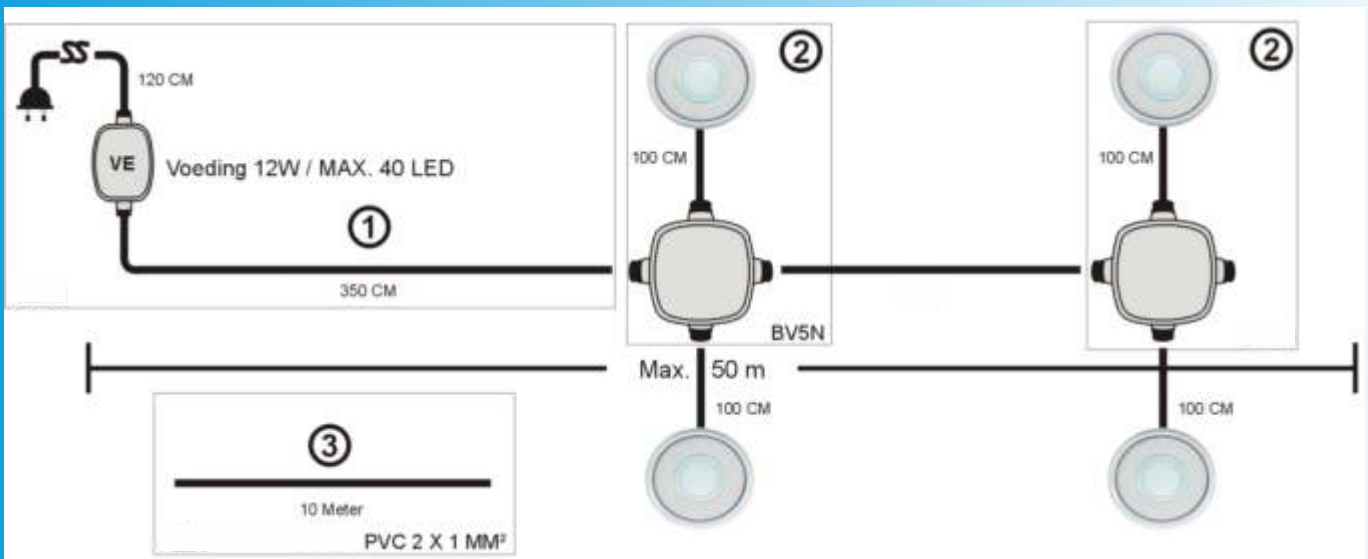

EYP180 - Outdoor PowerEYE EYEled

The PowerEYE High Performance (HP) Outdoor 180 Twin is a distinctly decorative, powerful ambient outdoor lighting solution.

The side-lit walkover LED luminaire is ideal for installation in outdoor landscape designs, decking, pavers, tile, boat docks, piers, sidewalks and driveways. The luminaire comes with the Eyeleds Outdoor Basic cabling system including a waterproof junction box which makes it ready and easy to install.

The product is made of high-grade aluminium with a grey-anodized finish. The 2700K warm white version delivers 180 lumens, emitted through two 70° cut-outs.

The PowerEYE HP 180 Outdoor Twin is used as a decorative marker light in exterior surfaces. The fitting recesses 60mm into a 50mm diameter hole, drilled through the surface of the material.

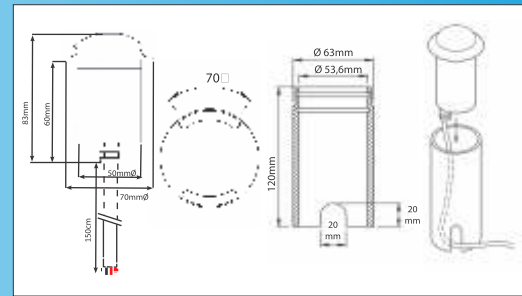
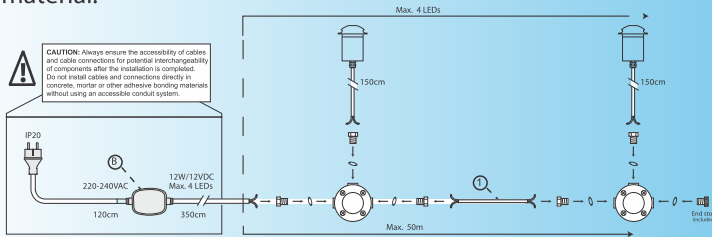

Class: III
 IP67 QC32
 Lamp: LED
 COLOUR

 LED COLOUR

L200 - Outdoor LED Ground Light

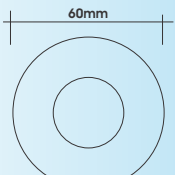

L200 Clear



Actual Size

L200 Frosted



Actual Size



L200 exploded view of fitting



L200 Round Recessed Floor LED

LED Colour: Cool White, Warm White, Blue
 Fitting Colour: Brushed Stainless Steel (316SS)
 Voltage: 12V 50Hz: Suitable for use with any Standard Wire-Wound 12V Transformer
 Wattage: 0,3W / Class III / IP 65
 Lamp Life: up to 100,000 hours
 Size: 60mm Diameter x 75mm Deep
 Cut-out: Sleeve Size 40mm OD
 QC33

JW617 - Outdoor LED Wall Light

165mm x 83mm x 80mm

The JW617 is a well designed fitting suitable for outdoor as well as indoor use.

It is an outdoor downlight or pathway light..

It is an aluminium fitting with a charcoal powder coated finish. It has a 3W Warm White COB LED light source and uses a 240V supply.

It has an IP54 rating which makes it splash proof from any angle. For interest sake an IP53 rating would be rain proof.

The exposed section is a single casting. The backing plate is fixed to the casting with two stainless steel screws and protected with silicone seals.

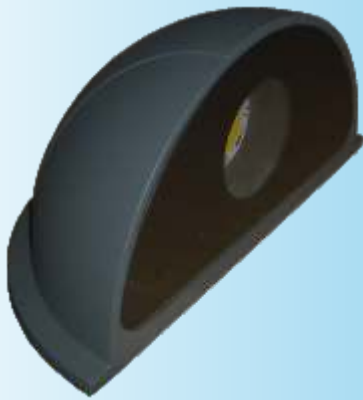

Class I
IP54
QC32
3W LED

COLOUR



JW50 "MYRA" Aluminium Up/Down Wall Light

Class: I
IP: 55
QC: 32
Lamp: 2 x GZ10
COLOUR



JLMR16cw3
GX5.3 Coolwhite 3W LED "Dichroic" Lamps
with 38degree lens



NOT DIMMABLE

NOW ALSO AVAILABLE IN WARMWHITE



JLGX53cw9
JLGX53ww9
Gx53 Coolwhite and Warmwhite
CFL Lamps

JAGZ10200
GZ10 LAMP HOLDER



JAL
"MR16
LAMP
HOLDER"



150mm Tails

JAC
"BRACKET"



GENERATOR SWITCH



Generator change over switch, 63Amp, 2 pole switch.

This switch is built from durable high quality components and is ideal for simultaneous Live and Neutral switching for hassle free change over from Mains to Generator power and vice versa.

Built in a surface mounted box making after market installation easy without having all the trouble of unnecessary building expense.

Specifications

Colour	Light Grey
Voltage input	240V
Dimensions	120 x 120 x 135
Environment	Indoors Only

Features & Benefits

Simultaneous Live and Neutral switching
Easy to install
Has built in LED lights to indicate power supply source.

ATE060



Is a 60W electronic transformer designed to work with 12V halogen and LED lamps. It is designed with class II protection against electric shock, open-circuit, short-circuit, overloading and overheating.

RT2 - Track Adaptor

90L x 35W x 25H
COMES WITH 50VA ELECTRONIC TRANSFORMER

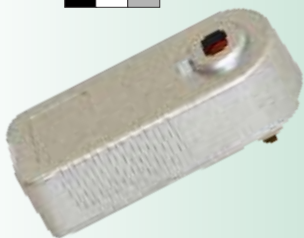

RT3 - Track Adaptor

120L x 35W x 25H
COMES WITH 50VA ELECTRONIC TRANSFORMER

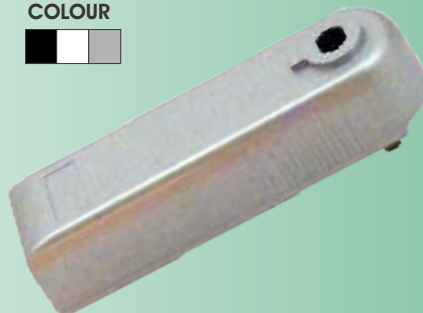

ATE300



Is a 300W electronic transformer designed to work with 12V halogen and LED lamps. It is designed with class II protection against electric shock, open-circuit, short-circuit, overloading and overheating.

All Fittings and Accessories to be installed by a qualified electrician.

Rotary

Wall Box Dimmers	500W	600W	1000W	1500W
Minimum Load	40W	60W	100W	150W
Maximum Resistive Load	500W	600W	1000W	1500W
Maximum Inductive Load	400W	500W	800W	1200W
Operating Voltage (+-10%)	230V	230V	230V	230V
Maximum Levers (4x2)	3(4)	3(4)	3(4)	3(4)
Maximum Levers (4x4)	4(5)	4(5)	4(5)	4(5)
Double Dimmers (4x4)	✓	✓	✓	✓
Double Dimmers (4x2)	✓	x	x	x
Triac Voltage	600V	600V	600V	600V
50W Low Voltage Lamps	8	10	16	24

Levers in Brackets refers to Switched Pot modules only



ALSO AVAILABLE IN
500W 4x2 DOUBLE DIMMER
(SWITCHED POT) FORMAT

Trailing Edge

350W Wall box trailing edge press button and rotary dimmers

1000W Remote press trailing edge press button and rotary dimmers

Suitable for electronic transformers only

Heavy Duty



Heavy Duty Surface or Remote-Mount Dimmers	2000W	3000W	4000W	10000W
Minimum Load	200W	300W	400W	1000W
Maximum Resistive Load	2000W	3000W	4000W	10000W
Maximum Inductive Load	1600W	2400W	3000W	8000W
Operating Voltage (+-10%)	230V	230V	230V	230V
Rotary	✓	✓	✓	✓
Bell-Press	✓	✓	x	x
Triac Voltage	600V	600V	600V	600V

Bell Press

Works with any n/o push button switch
(supplied seperately)

Bell Press Wall-Box Dimmer Modules	500W	800W	1000W
Minimum Load	40W	80W	100W
Maximum Resistive Load	500W	800W	1000W
Maximum Inductive Load	400W	600W	800W
Operating Voltage (+-10%)	230V	230V	230V
Triac Voltage	600V	600V	600V
50W Low Voltage Lamps	8	12	16



Bell press module and Crabtree "Classic" push button switch to fit standard cover plates.

Features:

- * 3-year manufacturer's guarantee
- * 600V Triac for reliability
- * Full range of spares
- * Technical support
- * Specials made to customer specs
- * 2-way/multi-way dimming with Bell-Press dimmers

INGRESS PROTECTION (IP) RATING

First Number

Protection against solid objects

1 - Hand protected - protected against foreign solid objects exceeding 50mm in diameter

2 - Finger protected - protected against finger contact with live parts; against solid objects exceeding 12mm in diameter.

3 - Tool protected - protected against contact with parts via tools, wire or similar objects over 2.5mm thick. Protection against penetration of solid objects exceeding 2.5mm in diameter.

4 - Wire protected - protected against contact with live parts by tools, wire or similar objects over 1mm thick; protection against penetration of solid objects exceeding 1mm in diameter.

5 - Dust accumulation protected - complete protection against contact with live parts and against harmful accumulation of dust; some dust may penetrate but not to the extent that operation is impaired.

6 - Dust penetration protected - complete protection against contact with live parts and against penetration of dust.

Please note:

Because of the test methods used, luminaires that comply with IP67/68 do not necessarily comply with IP65/66 requirements as well.

Second Number

Protection against moisture ingress

1 - drip proof against vertical drops of water - water drips falling vertically shall have no harmful effect.

2 - drip proof when tilted at angles up to 15° - water drips shall have no harmful effect.

3 - Rain/spray proof - water falling at an angle of up to 60° shall have no harmful effect.

4 - Splash proof - splashing water from any direction shall have no harmful effect.

5 - Jet proof - water projected by a nozzle from any direction shall have no harmful effect (Nozzle diameter 6.3mm; pressure 30kPa)

6 - Jet proof - water projected by a nozzle from any direction shall have no harmful effect (Nozzle diameter 12.5mm; pressure 100kPa)

7 - Watertight - temporary immersion in water under specified conditions of pressure and time possible without ingress of water in harmful quantities.

8 - Pressure watertight - continuous submersion in water under specified conditions of pressure and time without ingress of water in harmful quantities.





QUALITY (Q)

- 1 - Home Use - 8/24hr burning cycle
- 2 - Commercial Use - 14/24hr burning cycle
- 3 - Industrial Use - 24/24hr burning cycle

CORROSION RESISTANCE (C)

- 1 - Low - Indoor Use Only
- 2 - Medium - Inland - Indoor and outdoor
Coastal - Indoor only
- 3 - High - Outdoor use in coastal environments

SAFETY MARKS

CLASS I		Basic Insulation plus protective earth connector
CLASS II		Double or reinforced insulation. No provision for protective earthing
CLASS III		Supply of extra-low voltage - less than 25volts RMS Alternating Current (AC) or 60volts Direct Current (DC)
F MARK		Suitable for mounting on normally flammable surfaces Ignition temperature of materials greater than 200°C with some combustion time lag
F MARK		No F Mark indicates suitable for mounting on NON Flammable surface eg. Stone and Concrete

All Electrical Installations by qualified electricians only
Instructions on website for download and/or included in packaging

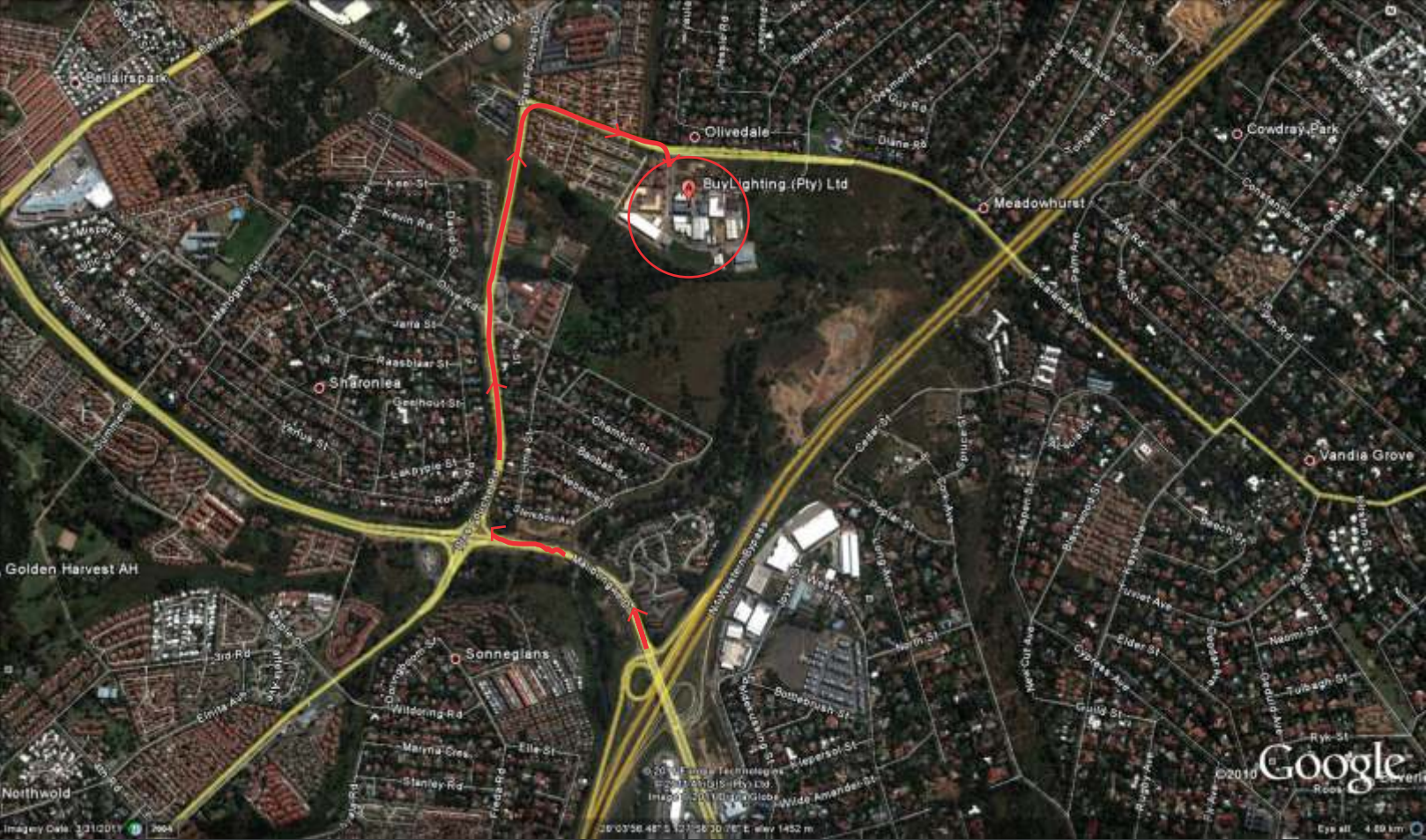

**Photometrics for
Osram 46870SP
50W dichroic lamp**

H(M)	∅	10°	E(lux)
0.3	12		97800
0.5	20		41800
1.0	40		11000
2.0	80		2800

**Photometrics for
Osram 46870WFL
50W dichroic lamp**

H(M)	∅	38°	E(lux)
0.3	29		17400
0.5	48		7440
1.0	97		2000
2.0	194		490

SHOWROOM AT
Unit 4, Stand 973
Meadowbrook Business Estate
Jacaranda Avenue
Olivedale, RANDBURG

Telephone: (011) 704-4033
Sharecall: 0860LIGHTS (544487)
Fax: (011) 704-1790
Email: sales@buylighting.co.za
<http://www.buylighting.co.za>

BUYLIGHTING
Light, Years Ahead !!!!!